

20.0A Surface Mount Trench Schottky Rectifier LOW VF

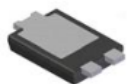

■ Features

- Low forward voltage drop.
- Excellent high temperature stability.
- Fast switching capability.
- Suffix "G" indicates Halogen-free part, ex. CP10S45SG.
- Lead-free parts meet environmental standards of MIL-STD-19500 /228

■ Mechanical data

- Epoxy : UL94-V0 rated flame retardant.
- Case : Molded plastic, TO-277.
- Lead : Solder plated, solderable per MIL-STD-750, Method 2026.
- Polarity: Indicated by cathode band.
- Mounting Position : Any.
- Weight : Approximated 0.093 grams.

VOLTAGE RANGE 45 Volts

CURRENT 20.0 Ampere

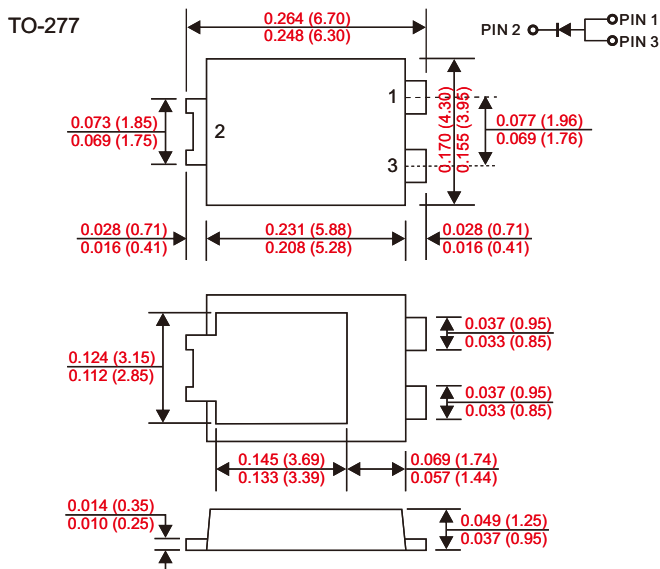

MAXIMUM RATINGS AND ELECTRICAL CHARACTERISTICS

Rating 25°C ambient temperature unless otherwise specified.
Single phase half wave, 60Hz, resistive or inductive load.
For capacitive load, derate current by 20%.

TYPE NUMBER	SB2045L	UNITS
Maximum Recurrent Peak Reverse Voltage	45	V
Maximum RMS Voltage	32	V
Maximum DC Blocking Voltage	45	V
Maximum Average Forward Rectified Current		
See Fig. 1	20.0	A
Peak Forward Surge Current, 8.3 ms single half sine-wave superimposed on rated load (JEDEC method)	200	A
Maximum Instantaneous Forward Voltage at 20.0A	0.52	V
Maximum DC Reverse Current Ta=25°C	0.3	mA
at Rated DC Blocking Voltage Ta=100°C	20	mA
Typical Junction Capacitance (Note1)		pF
Typical Thermal Resistance R JA (Note 2)	31	°C/W
Operating Temperature Range Tj	-65 — +150	°C
Storage Temperature Range Tstg	-65 — +150	°C

Note : 1.FR-4 PCB, 2oz.Copper.

2. Polyimide PCB, 2oz.Copper.Cathode pad dimensions 18.8mm x 14.4mm.Anode pad dimensions 5.6mm x 14.4mm.

RATING AND CHARACTERISTIC CURVES (SB2045L LOWVF)

Fig. 1 - Forward Power Dissipation

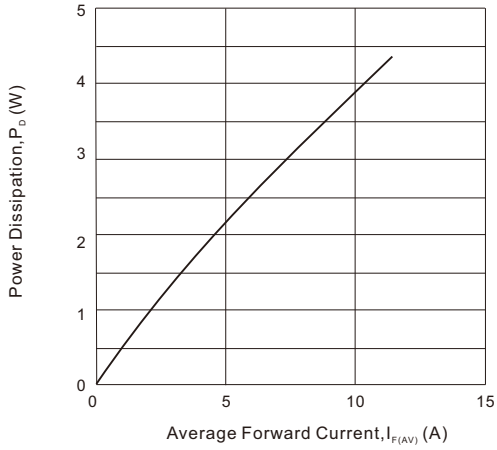

Fig. 2 - Instantaneous Forward Characteristics

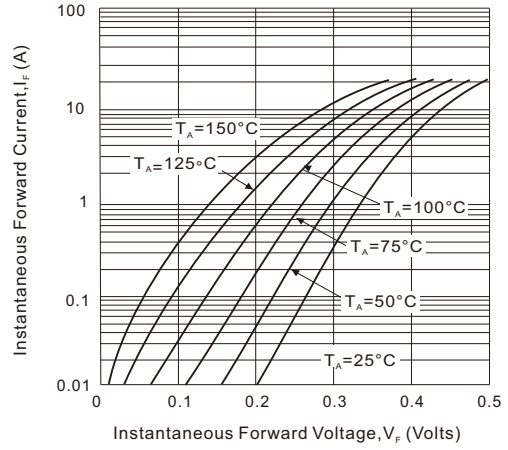

Fig. 3 - Reverse Characteristics

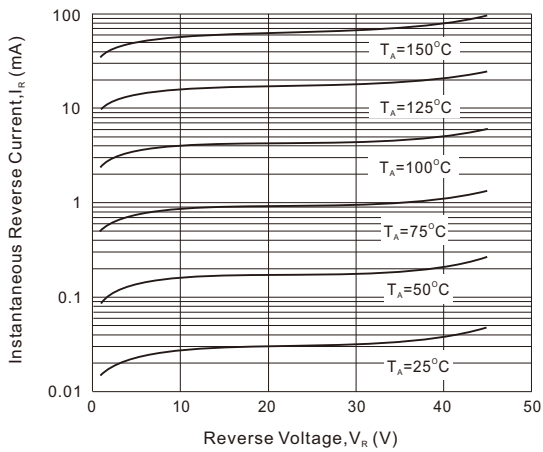

Fig. 4 - Forward Current Derating Curve

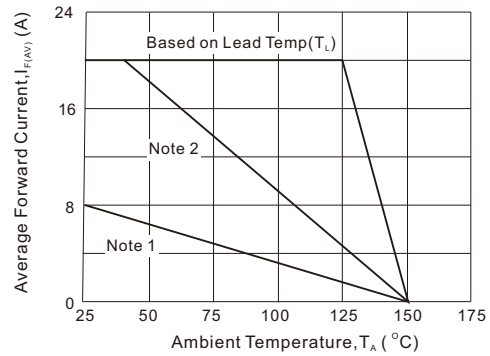

Fig. 5 - Total Capacitance VS. Reverse Voltage

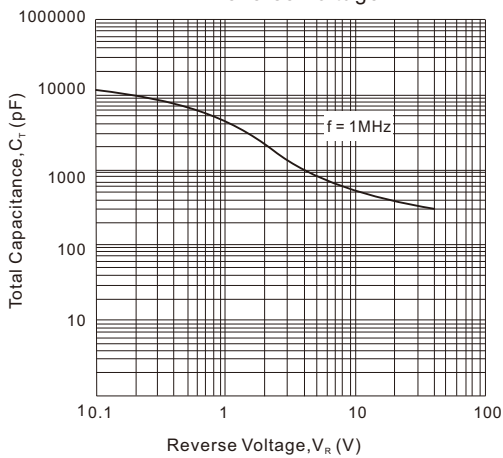

Fig. 6 - Maximum Avalanche Power Curve

